

# CALIBRE – KALIBER – CALIBRE

## 2201 A

 $16\frac{1}{2}'''$ 

ø 36,60 mm

Hauteur mouvement  
Werkhöhe  
Movement height

4,50 mm

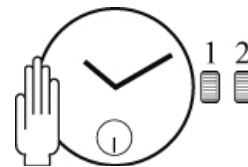

Réserve de marche / Gangreserve / Running time

53 h

Nombre de rubis / Anzahl Rubine / Number of jewels

17

Angle de levée du balancier / Hebungswinkel der Unruh / Angle of lift of balance

44°

Fréquence / Frequenz / Frequenzy

3 Hz (21'600 A/h)

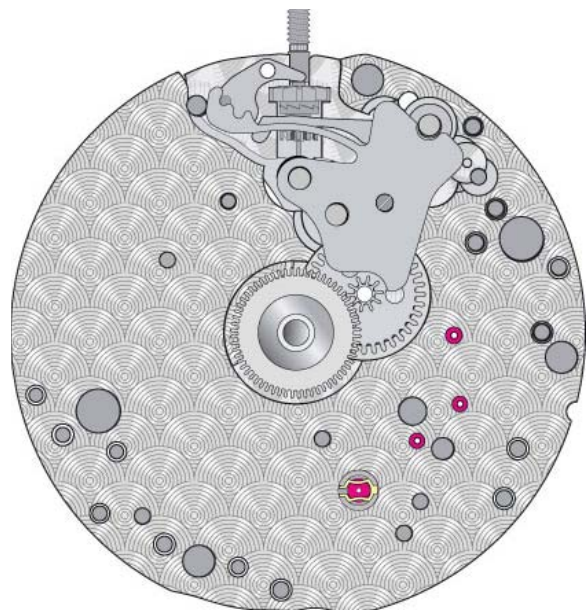
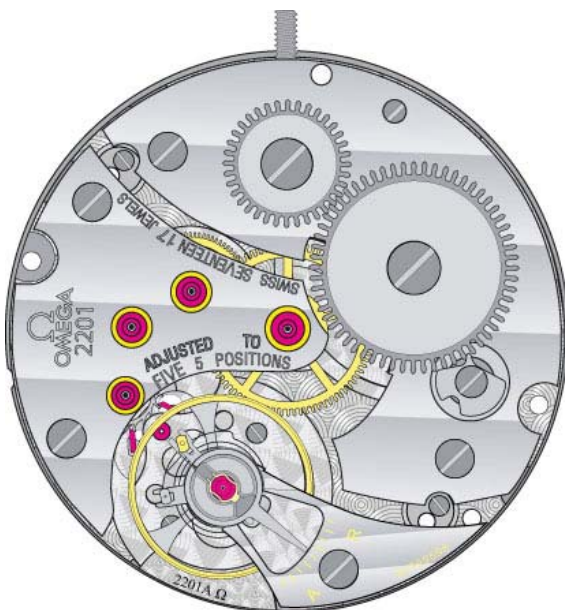

Français  
Deutsch  
English

---

## Informations générales - Allgemeine Informationen - General information

### Outillage

Porte-pièces pose  
aiguilles Cal. 2201 507 0060

### Werkzeug

Werkhalter zum  
Zeigersetzen Cal. 2201 507 0060

### Tools

Movement holder for  
hand fitting Cal. 2201 507 0060

### Lubrifiants

Moebius 9010 (2ml) 504 200 0001  
Moebius SYNT-HP 1300 504 5013  
Moebius 9504 504 5014  
Moebius 9415 504 100 0003

### Schmiermittel



Moebius 9010 (2ml) 504 200 0001  
Moebius SYNT-HP 1300 504 5013  
Moebius 9504 504 5014  
Moebius 9415 504 100 0003

### Lubricants

Moebius 9010 (2ml) 504 200 0001  
Moebius SYNT-HP 1300 504 5013  
Moebius 9504 504 5014  
Moebius 9415 504 100 0003

**Liste des fournitures par ordre d'assemblage**  
**Bestandteilliste in Montager Reihenfolge**  
**Parts listed in order of assembly**

1 = 10.020.07	8 = 61.100
2 = 31.121	9 = 31.100
3 = 31.120	10 = 31.101
4 = 51.010.23	11 = 31.041
5 = 51.080	12 = 51.090
6 = 3558 (1x)	13 = 3559 (1x)
7 = 51.050	

	Huile épaisse Dickflüssiges Öl Thick oil	<b>Moebius HP-1300</b>
	Graisse Fett Grease	<b>Moebius 9504</b>

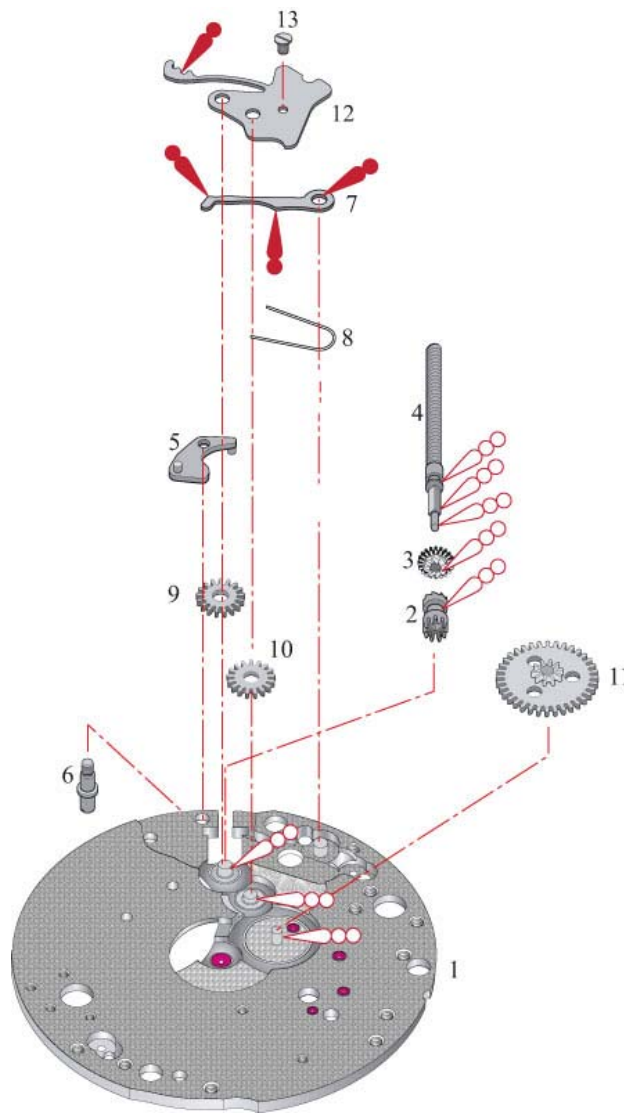

**Liste des fournitures par ordre d'assemblage**  
**Bestandteilliste in Montager Reihenfolge**  
**Parts listed in order of assembly**

1 = 10.020.07	13 = 3560 (2x)
2 = 30.040	14 = 40.050.21
3 = 30.027.01	10.058.61
4 = 30.025	15 = 3533 (1x)
5 = 30.015	16 = 81.067
6 = 10.048.07	17 = 31.023
7 = 3533 (2x)	18 = 3556 (1x)
8 = 20.010	19 = 61.080
9 = 10.041.07	20 = 51.120
10 = 3533 (3x)	21 = 3557 (1x)
11 = 40.010	22 = 31.020
12 = 10.057.07	23 = 3555 (1x)

Huile fine  
 Dünflüssiges Öl  
 Fine Oil

**Moebius 9010**

Huile épaisse  
 Dickflüssiges Öl  
 Thick oil

**Moebius HP-1300**

Graisse spéciale pour échappement  
 Spezialfett für Hemmung  
 Special grease for escapement

**Moebius 9415**

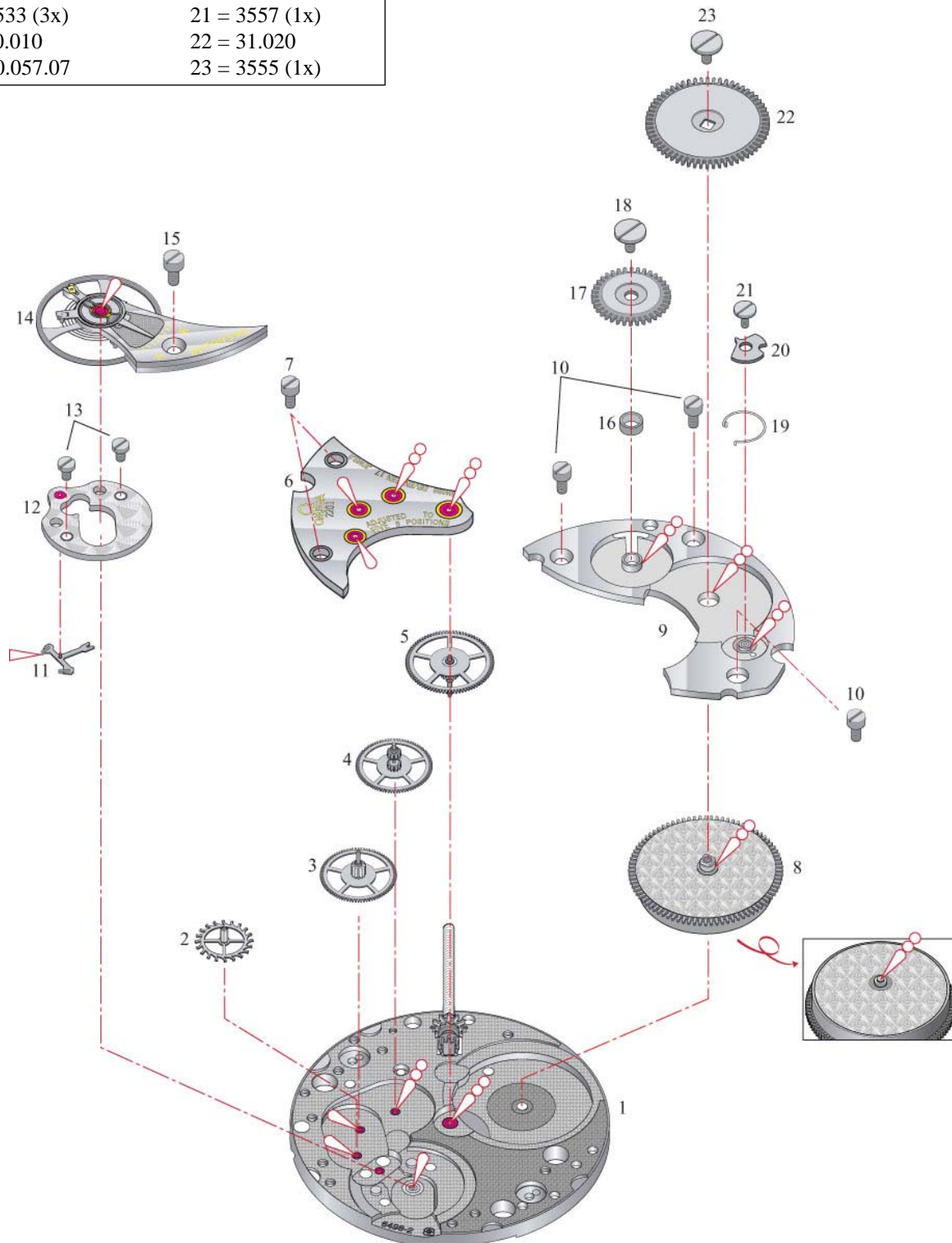

**Liste des fournitures par ordre d'assemblage**  
**Bestandteilliste in Montagerihenfolge**  
**Parts listed in order of assembly**

1 = 10.020.07      3 = 31.046.01  
 2 = 31.080.01      4 = 1298

Très faible quantité  
 Sehr kleine Menge  
 Very little quantity

**Moebius HP-1300**

Graisse  
 Fett  
 Grease

**Moebius 9504**

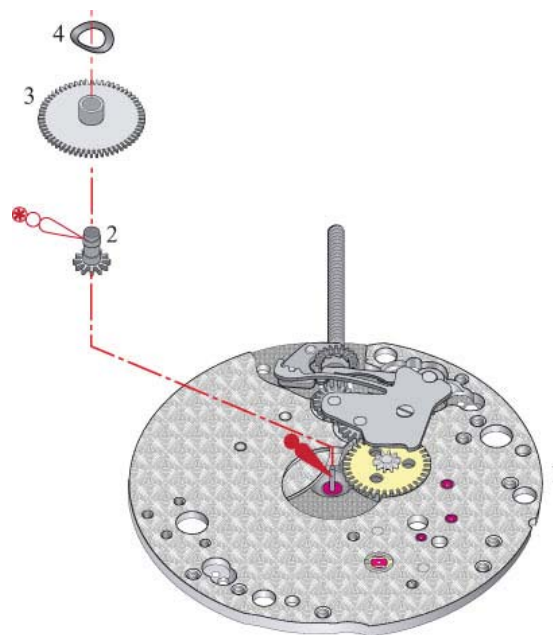

## Liste des fournitures - Bestandteilliste - Spare parts list

				(6x)
10.020.07	10.020.07	10.041.07		3533
				(1x)
10.048.07	10.057.07	10.058.61	1298	3555
				(1x)
30.015	30.025	30.027.01	30.040	3556
				(1x)
31.020	31.023	31.041	31.100	3557
				(1x)
31.046.01	31.080.01	31.101	31.120	3558
				(1x)
40.100.21	40.120	40.200	40.302.23	3559
				(2x)
51.010.23	51.050	51.080	70.530	3560
70.531	81.067			



Cal.	No CS	Désignation	Bezeichnung	Designation
2201A	10.020.07	Platine	Werkplatte	Main plate
2201A	10.041.07	Pont de barillet	Federhausbrücke	Barrel bridge
2201A	10.048.07	Pont de rouage	Räderwerkbrücke	Train wheel bridge
2201A	10.057.07	Pont d'ancre	Ankerbrücke	Pallet bridge
2201A	10.058.61	Pont de balancier pour raquette à flèche, amortisseur et porte-piton Etachron	Unruhbrücke für Rucker mit Stiel Stossicherung und Spiral-klötzchenträger Etachron	Balance bridge for regulator with pointer, shock-absorber and stud support Etachron

Cal.	No CS	Désignation	Bezeichnung	Designation
2201A	1298	Clinquant	Flitter	Metal foil
2201A	20.010	Barillet complet	Federhaus vollständig	Movement barrel
2201A	20.100	Ressort-moteur	Triebfeder	Mainspring
2201A	30.015	Roue de centre	Minutenrad	Centre wheel
2201A	30.025	Roue moyenne	Kleinbodenrad	Third wheel
2201A	30.027.01	Roue de seconde, H1 (= 3,84 mm)	Sekundenrad, H1 (= 3,84 mm)	Second wheel, H1 (= 3,84 mm)
2201A	30.040	Roue d'échappement	Hemmungsrad	Escape wheel
2201A	31.020	Rochet	Sperrad	Ratchet wheel
2201A	31.023	Roue de couronne	Kronrad	Crown wheel
2201A	31.041	Roue de minuterie	Wechselrad	Minute wheel
2201A	31.046.01	Roue des heures, H1 (= 1,30 mm)	Stundenrad, H1 (= 1,30 mm)	Hour wheel, H1 (= 1,30 mm)
2201A	31.080.01	Chaussée entraîneuse, H1 (= 2,15 mm)	Mitnehmer-Minutenrohr H1 (= 2,15 mm)	Driver cannon pinion H1 (= 2,15 mm)
2201A	31.100	Renvoi	Zeigerstellrad	Setting wheel
2201A	31.101	Renvoi intermédiaire	Zwischen-Zeigerstellrad	Intermediate setting wheel
2201A	31.120	Pignon de remontoir	Aufzugtrieb	Winding pinion
2201A	31.121	Pignon coulant	Kupplungtrieb	Sliding pinion
2201A	40.010	Ancre	Anker	Pallet fork
2201A	40.050.21	Balancier annulaire, réglé pour amortisseur et porte-pitón Etachron	Unruh mit glatten Reif, reguliert für Stossicherung und Spiral- klötzchenträger Etachron	Timed annular balance for shock-absorber and stud support Etachron
2201A	40.100.21	Axe de balancier (pour amortisseur et balancier annulaire)	Unruhwelle (für Stossicherung und Unruh mit glattem Reif)	Balance staff (for shock-absorber and annular balance)
2201A	40.120	Plateau double	Doppelscheibe	Double roller
2201A	40.200	Porte-pitón	Spiralklötzchen-Träger	Stud support
2201A	40.302.23	Raquette + flèche	Rücker, zweiteilig	Two-piece regulator
2201A	51.010.23	Tige de remontoir, diamètre de filetage 1,20 mm	Aufzugwelle, Gewinde- durchmesser 1,20 mm	Winding stem, thread diameter 1,20 mm
2201A	51.050	Bascule de pignon coulant	Kupplungtriebhebel	Yoke
2201A	51.080	Tirette	Winkelhebel	Setting lever
2201A	51.090	Sautoir de tirette	Winkelhebelraste	Setting lever jumper
2201A	51.120	Cliquet	Klinke	Click
2201A	61.080	Ressort de cliquet	Klinkenfeder	Click spring
2201A	61.100	Ressort de bascule	Kupplungshebelfeder	Yoke spring
2201A	70.530	Amortisseur empierré de balancier, à chasser, à portée, dessus	Stossicherung mit Stein, für Unruh, zum Einpressen mit Auflage, oben	Jewelled shock-absorber, for balance, to press in, cylindrical, top
2201A	70.531	Amortisseur empierré de balancier, à chasser, à portée, dessous	Stossicherung mit Stein, für Unruh, zum Einpressen mit Auflage, unten	Jewelled shock-absorber, for balance, to press in, cylindrical, bottom
2201A	81.067	Bague de roue de couronne	Kronradring	Crown wheel ring
2201A	3533	3x Vis de pont de barillet	Schraube für Federhausbrücke	Screw for barrel bridge
2201A	3533	2x Vis de pont de rouage	Schraube für Räderwerkbrücke	Screw for train wheel bridge
2201A	3533	1x Vis de pont de balancier	Schraube für Unruhbrücke	Screw for balance bridge
2201A	3555	1x Vis de rochet	Schraube für Sperrad	Screw for ratchet wheel
2201A	3556	1x Vis de roue de couronne	Schraube für Kronrad	Screw for crown wheel
2201A	3557	1x Vis de cliquet	Schraube für Klinke	Screw for click
2201A	3558	1x Vis de tirette	Schraube für Winkelhebel	Screw for setting lever
2201A	3559	1x Vis de sautoir de tirette	Schraube für Winkelhebelraste	Screw for setting lever jumper
2201A	3560	2x Vis de pont d'ancre	Schraube für Ankerbrücke	Screw for pallet bridge



	Guide technique / Technische Anleitung / Technical Guide		TG-19-C-028-FDE	B
	Made by: pelrom	Date: 10.03.2005		

Release of Technical Guide				
Date of first release:	13.10.2004	Version A	Made by:	Pelrom
Date of last release:	10.03.2005	Version B		

Traceability of modifications			
<i>Replacement of lubricants</i>			
	Old	New	Date:
	Moebius Microgliss D5	Moebius SYNT-HP-1300	10.03.2005
	Moebius 9501	Moebius 9504	